

DATAX 37.110

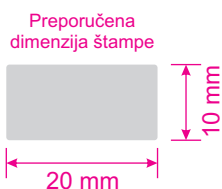

FLIP 37.100.88

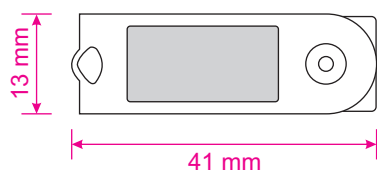
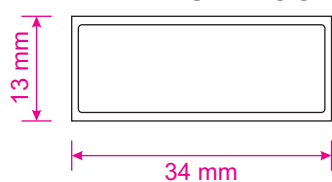

ELTEC 37.120

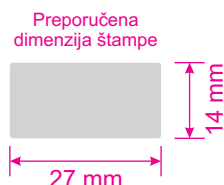
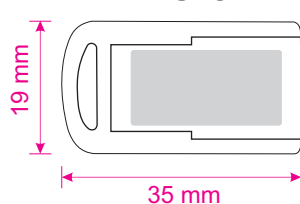

CREDIT CARD 37.101.90

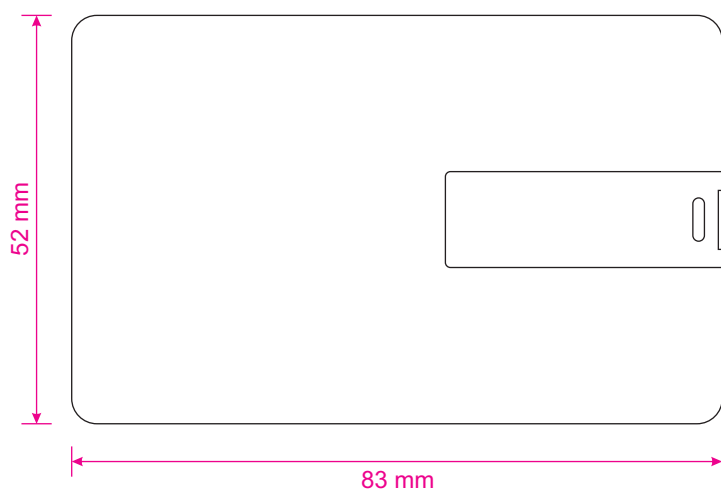

* Prednja strana

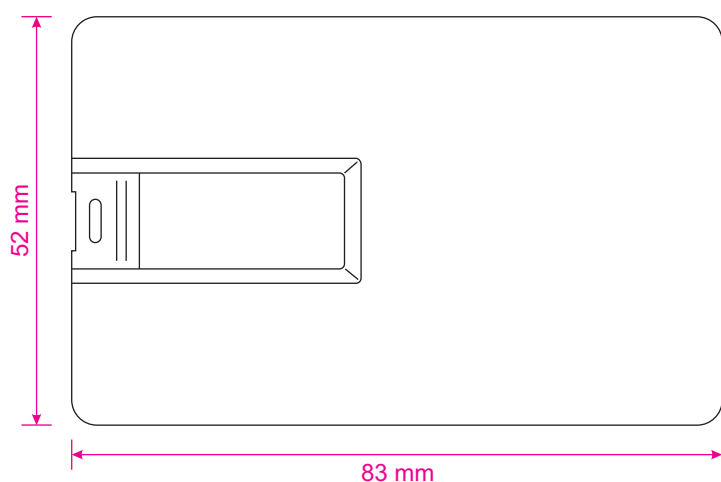

* Zadnja strana

Ukoliko želite uslugu štampe, obavezno priložiti pripremu za štampu u sledećem obliku:

-CREDIT CARD i FLIP – fotografija u 300dpi / CMYK (u razmeri 1:1) ili u vektorskom formatu (preporučujemo CDR format)

* Za proizvode FLIP i CREDIT CARD prilikom izrade grafičke pripreme uraditi prepust od 1mm sa sve četiri strane

-DATAX i ELTEC - u vektorskom formatu (preporučujemo CDR format)